

# e1X



DAC/Control Preamp

USER GUIDE



## DAC Control/Preamp

### TABLE OF CONTENTS

Safety Information	2
Certifications/Standards	2
Warranty	3
Unpacking	3
Power Connection	3
Setup and Placement	3
System Connections	4
E1X DAC Control and Display Options	5
E1X DAC Programming	5
Programming Options	6-7
Connecting to Your Network	8
Using the SEEK App	9-11
Specifications	12
Declaration of Conformity	13

Copyright © 2019 Bel Canto Design Ltd.  
Bel Canto Design Limited  
221 North 1<sup>st</sup> Street Suite 300  
Minneapolis, MN 55401  
United States

All rights reserved. No part of this publication may be reproduced, stored in a retrieval system, or transmitted, in any form or by any means, electronic, mechanical, photocopying, recording, or otherwise, without the prior written permission of Bel Canto Design. The content of this manual is provided for information use only, is subject to change without notice, and should not be construed as a commitment by Bel Canto Design Limited. Bel Canto Design Limited assumes no responsibility or liability for any errors or inaccuracies that may appear in this manual. Bel Canto Design Limited disclaims any proprietary interest in trademarks and trade names other than its own. Printed in the United States.

## Important Safety Instructions

Explanation of symbols used in this manual or on the rear/underside of the apparatus:



The Lightning Flash with arrowhead symbol within an equilateral triangle is intended to alert the user to the presence of uninsulated "dangerous voltage" within the product enclosure that may be of sufficient magnitude to constitute a risk of shock to persons.



The exclamation point within an equilateral triangle is intended to alert the user to the presence of important operating and maintenance (servicing) instructions in the literature accompanying the product.

TO COMPLETELY DISCONNECT THIS APPARATUS FROM THE AC MAINS, DISCONNECT THE POWER SUPPLY CORD PLUG FROM THE AC RECEPTACLE.

THE MAINS PLUG OF THE POWER SUPPLY CORD SHALL REMAIN READILY ACCESSIBLE.

Disconnect supply cord before changing fuse.  
Refer servicing to qualified service personnel.

WARNING: TO REDUCE THE RISK OF FIRE OR ELECTRIC SHOCK, DO NOT EXPOSE THIS APPARATUS TO RAIN OR MOISTURE AND OBJECTS FILLED WITH LIQUIDS, SUCH AS VASES, SHOULD NOT BE PLACED ON THIS APPARATUS.

- Read, keep and follow these instructions.
- Heed all warnings.
- Do not use the apparatus near water, e.g. near a bathtub, kitchen sink, laundry tub, in a wet basement, near a swimming pool etc.
- Clean only with a dry cloth.
- Install in accordance with the Manufacturer's instructions.
- Do not install near any heat sources such as radiators, heat registers, stoves, or other apparatus that produce heat.
- Do not defeat the safety purpose of the polarized or grounding type plug. A polarized plug has two blades with one wider than the other. A grounding type plug has two blades and a third grounding prong. The wide blade or the third prong is provided for your safety. If the provided plug does not fit into your outlet; consult an electrician for replacement of the obsolete outlet.
- Protect the power cord from being walked on or pinched particularly at plugs, convenience receptacles, and at the point where they exit from the apparatus.
- Unplug this apparatus during lightning storms or when unused for long periods of time.
- Refer all servicing to qualified service personnel. Servicing is required when the apparatus has been damaged in any way, such as power-supply cord or plug has been damaged, liquid has been spilled or objects have fallen into the apparatus, the apparatus has been exposed to rain or moisture, does not operate normally, or has been dropped.
- Mains plug: Use the mains plug to disconnect the apparatus from the mains supply. The mains plug must be accessible at all times. Use the mains switch (if applicable) when the apparatus is not in use.
- Do not expose the apparatus to liquids or moisture, dripping or splashing. Do not place a vessel containing liquid on top of the apparatus.
- No naked flame sources, such as lighted candles, should be placed on the apparatus.
- The apparatus has been designed for use in moderate and tropical climates

### In the U.K.

Fuse replacement: This appliance is fitted with a non-rewireable 10 amp mains plug. The plug contains a 10 amp fuse. If the fuse has blown it can be replaced as follows: 1) Pull out the black fuse cover/carrier. 2) Remove and dispose of the blown fuse. 3) Fit a new 10 amp BS1362 approved fuse into the carrier and push the carrier back into the plug. Always ensure the fuse cover is fitted. If the fuse cover is missing do not use the plug. Contact your Bel Canto retailer to obtain a replacement fuse cover. Fuses are for fire protection and do not protect against electric shock.



WARNING: THIS APPLIANCE MUST BE GROUNDED

### FCC Notice

Note: This equipment has been tested and found to comply with the limits for a Class B digital device, pursuant to Part 15 of the FCC Rules. These limits are designed to provide reasonable protection against harmful interference in a residential installation. This equipment generates, uses, and can radiate radio frequency energy and, if not installed and used in accordance with the instructions, may cause harmful interference to radio communications. However, there is no guarantee that interference will not occur in a particular installation. If this equipment does cause harmful interference to radio or television reception, which can be determined by turning the equipment off and on, the user is encouraged to try to correct the interference by one or more of the following measures:

- Reorient or relocate the receiving antenna.
- Increase the separation between the equipment and receiver.
- Connect the equipment into an outlet on a circuit different from that to which the receiver is connected.
- Consult the dealer or an experienced radio/TV technician for help.

## Warranty Information

Bel Canto products are automatically covered by a 90 day factory warranty that covers all internal parts and labor. Register online (<http://www.belcantodesign.com/home/support/warranty-registration/e1x/>) within 30 days of purchase from an authorized dealer to automatically extend your warranty for 5 years starting from the date of purchase. If you do not have web access, please contact your dealer for assistance. Upon fully completing registration, within 5 business days you will receive an email that officially validates your warranty. Your information will be used for internal use only and will not be sold or released outside Bel Canto. Your comments and suggestions are appreciated and help us continually improve our products and services.

The warranty is only valid to the original owner and is non-transferable. Damage caused by unauthorized modification, abuse, or neglect of product will void your warranty. Any cost associated with return of product is the sole responsibility of the owner. All returns require a return authorization number issued after contacting us at [info@belcantodesign.com](mailto:info@belcantodesign.com). If you have any questions, please feel free to contact us online at [info@belcantodesign.com](mailto:info@belcantodesign.com).

## Unpacking the E1X DAC Control/Preamp

Carefully inspect each item for any visual damage. If there is any damage, or anything missing from the list below, please contact your dealer or distributor.

The below items are shipped with your system:

- 1 (one) – E1X DAC Control/Preamp
- 1 (one) – User's Guide
- 1 (one) – Remote Control
- 1 (one) – IEC Power Cable
- 1 (one) – BNC/RCA Adapter

**IMPORTANT:** Save all packing materials as they are specially designed to protect the E1X DAC during transportation. If the packing materials are compromised, contact your dealer, distributor, or Bel Canto for proper packaging before attempting to ship your E1X DAC.

## Power Connection

The power supply in the E1X DAC is preset for the proper power voltage. The power cable should have the correct plug for your local power system. If you believe this to not be true, please contact your dealer immediately. This product, like any electrical component, can be dangerous and cause injury unless correct handling procedures are observed and used. Before powering this product, it is necessary to read and follow proper setup and procedures.



## Setup & Placement

The E1X DAC can be placed in many locations without compromise. We do not recommend placing weights or other objects directly on E1X DAC. This may scratch or mar the chassis finish. Do not use harsh chemicals or abrasives when cleaning the outside of your E1X DAC. Use a clean microfiber cloth to remove fingerprints from the chassis.

Single Ended RCA and Balanced XLR connectors are available. XLR connectors follow the standard AES pin configuration:

- Pin 1 Ground
- Pin 2 Signal +
- Pin 3 Signal -

We recommend placing the E1X DAC in an easily accessible location near your source components.

# System Connections



1. **Main Outputs** in Balanced XLR or RCA formats can be connected directly to your chosen amplifier.
2. **Ground Lug** is provided to attach ground wire from your turntable.
3. **MM/MC Phono Input** for your phono cartridge. Gain and load settings are available through Program Mode.
4. **Analog Inputs** are 2V line level and support a variety of analog sources. Each of these inputs can be set for HTB (Home Theater Bypass) with a fixed volume setting of 84.0 applied for use with a home theater preamplifier output.
5. **Analog Outputs** can be used to feed a powered subwoofer or other devices, 4.5Vrms Max out.
6. **RS232** allows control from any compatible controllers.
7. **AES XLR Input** accepts digital signal with data rates up to 24 bit 192 KS/s.
8. **SPDIF Input** accepts digital signal with data rates up to 24 bit 192 KS/s.
9. **TOSLINK Input** accepts digital signal with data rates up to 24 bit 192 KS/s.
10. **USB Input** accepts digital signal with data rates up to 24 bit 384 KS/s, MQA, and DSD64/128 in DoP format.
11. **Ethernet Input** accepts digital audio data rates up to 24 bit 192 KS/s and DSD64 in DSF format. This input supports MQA, is UPnP/DLNA compatible and a 'Roon Ready' endpoint. Roon is a sophisticated and friendly means to access your music collection and stream Tidal, including Tidal Masters (MQA) from the internet. We recommend that you investigate Roon's capabilities with the knowledge that you will be getting the best audio performance possible through our 'Roon Ready' network interface. More info at <https://roonlabs.com/>
12. **USB A Input** is used to connect to an external FAT32 formatted USB storage device. Use the SEEK app to stream music from the connected drive. The E1X DAC can support Bus Powered USB drives up to 1 amp or any externally powered USB storage device.
13. **Mains Power Switch** connects AC input to the power board when set to the I positions.
14. **IEC Inlet.** Region specific voltage is internally set.

\*MQA (Master Quality Authenticated) is an award-winning British technology that delivers the sound of the original master recording. The master MQA file is fully authenticated and is small enough to stream or download.

\*\*MQA core decoding recovers all the direct music-related information. Output is 88.2kHz or 96kHz

Visit [mqa.co.uk](http://mqa.co.uk) for more information. MQA and the Sound Wave Device are registered trademarks of MQA Limited ©2016

The MQA logo is a trademark of MQA Limited. © MQA Limited 2017

The E1X DAC includes MQA technology, which enables you to play back MQA audio files and streams, delivering the sound of the original master recording. The display will show "MQA" when playing an MQA stream or file or "MQA." for an MQA Studio file, which has either been approved in the studio by the artist/producer or has been verified by the copyright owner.

# E1X DAC Control and Display Options

You can select inputs, adjust volume, and program the E1X DAC by using any of the remote control or the wheel.

Additionally, you can manage your music library, networked or USB A connected devices, and TIDAL using the Bel Canto SEEK app for iOS.

The default display will show the selected input on the left and the volume on the right.

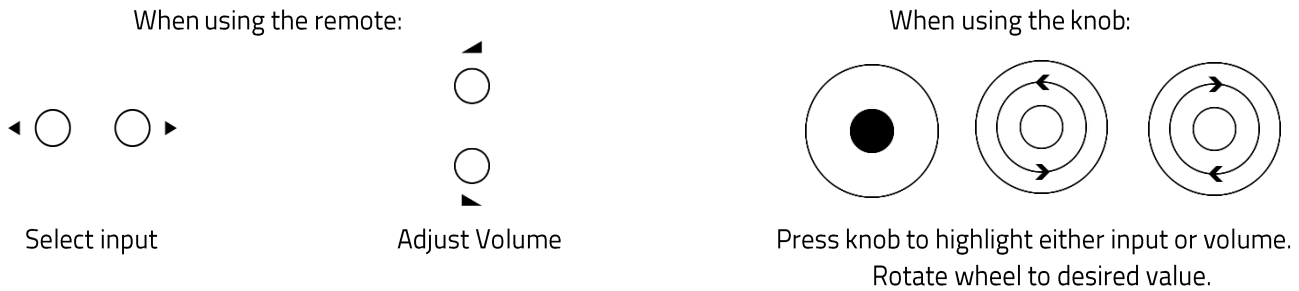

The E1X DAC has several additional display options. Pressing the 'Display' button on the remote will cycle through the options available for the selected Input. The display may also be turned off by pressing the 'Display' button until the display is no longer illuminated.

## E1X DAC Programming

The E1X DAC has an abundance of features that can be accessed in programming mode. To begin programming via the remote: press the 'Program' button in the upper right of the remote.

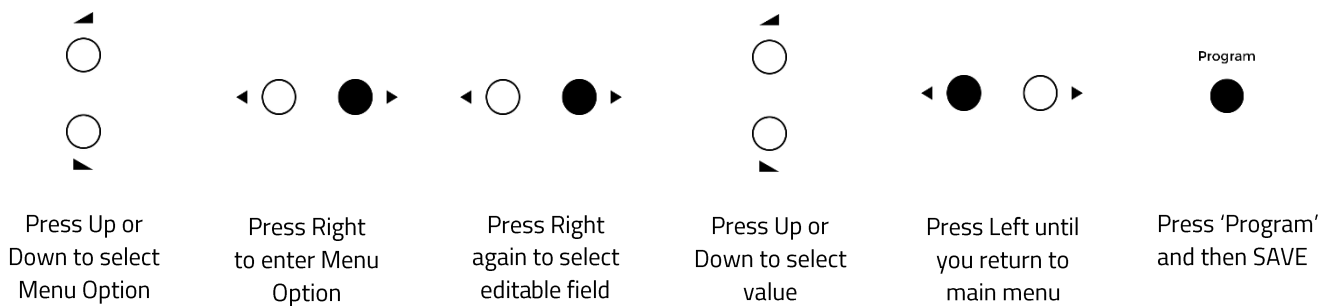

For programming via the knob:

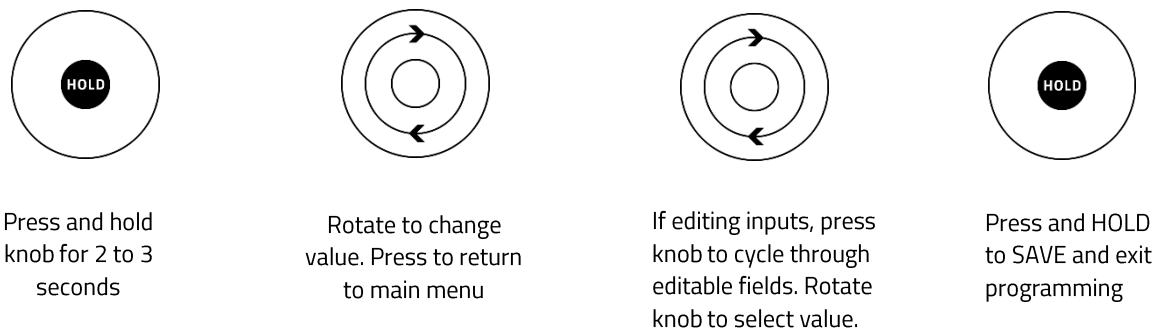

# Programming Options

## Tilt: OFF

Tilt control centers at 775Hz and tilts the frequency spectrum up or down in 0.6dB increments (-5, OFF, +5), to a maximum of +/-3dB. This control allows you to finely tailor the overall tonal balance of your system to optimally match your room, your loudspeakers and your personal taste without compromising the sonic integrity of the original signal.

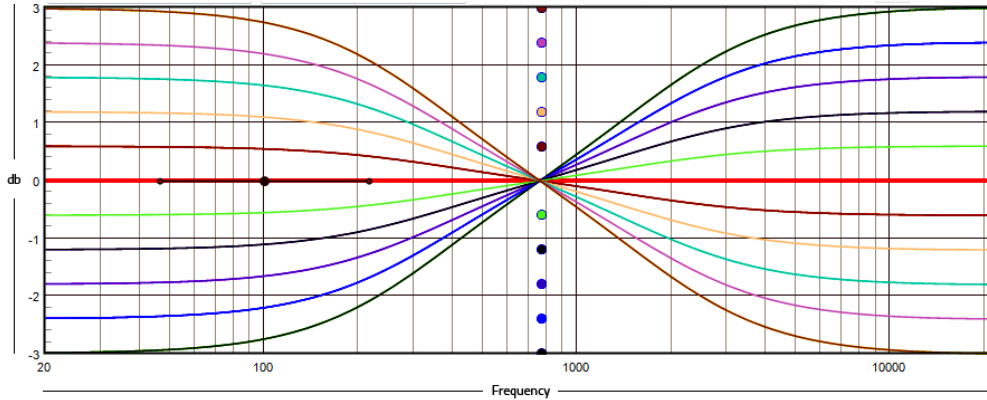

This graphical example of our tilt control settings shows the frequency tilt spectrum at 775Hz in 0.6dB increments from +3dB to -3dB.

## Bass EQ: OFF

Bass EQ control operates over a +/-3dB range with 0.6dB increments (-5, OFF, +5), providing subtle optimization of your system bass energy.

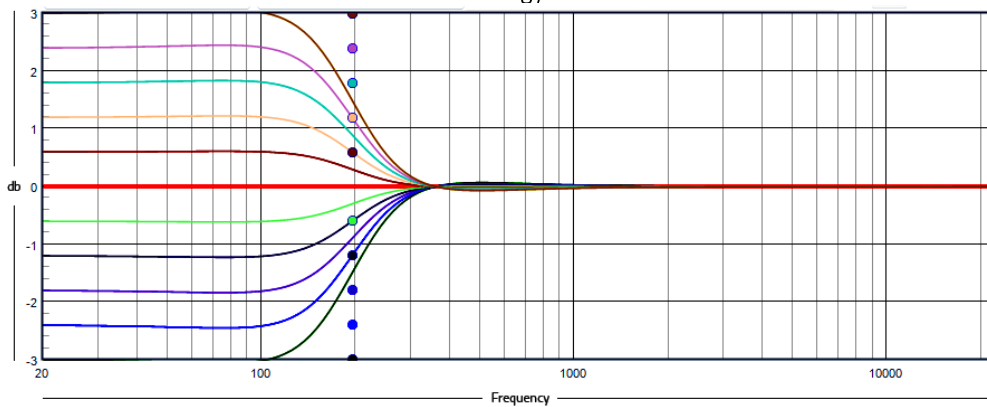

This graphical example of our bass EQ settings shows the low shelf curve in 0.6dB increments from +3dB to -3dB at 100Hz.

## Main HP: OFF

Main HP is used to set a 2<sup>nd</sup> order High Pass filter for the main loudspeaker output to better integrate a subwoofer. Frequency range is 40Hz to 120Hz in 10Hz increments or OFF for no HP filter.

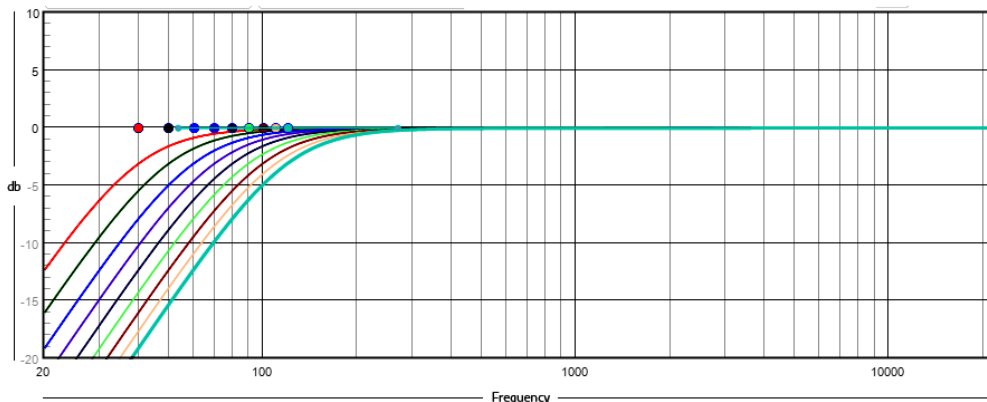

This graphical example of our Main High Pass Filter function from 40Hz to 120Hz in 10Hz increments.

# Programming Options

## Sub LP: OFF

Sub LP is used to set a 2<sup>nd</sup> order Low Pass filter for the Analog Line output to better integrate a subwoofer. Frequency range is 40Hz to 120Hz in 10Hz increments or OFF for no LP filter.

## Sub Gain: 0

Sub Gain on the Line output is adjustable from -6dB to +6dB in 1dB steps.

## Phono: 5mV

Select the setting that is appropriate for your cartridge.

Setting	Gain
5.0 mv	40dB-MM
2.5 mv	46dB-MM
0.5 mv	60dB-MC
0.25 mv	66dB-MC

## Load: 47k

Then select from the following cartridge loads: 47kohm or 1000, 500, 100, or 50ohms.

## HPhone: OFF

Turning Headphone ON will cut off audio to the loudspeakers and divert signal to the headphone output.

## Max Volume: 85.0

Max volume level limit can be set up to 100.0. Default is 85.0.

## Phase: 0

Choose 'Normal' or 'Inverted.' Inverted phase will show a hyphen to the left of the volume.

## Edit Input

Each individual input can be turned OFF or back ON. An output that is turned OFF will be hidden when you scroll through selectable input options while playing music. The input name can be customized with up to 4 alphanumeric characters.

## Reset PGM

Reset all settings to factory default.

## Update FW

Connect the E1X DAC to the internet via Ethernet and check for firmware updates. Press right and then up to select UPDATE: YES. Then press right again to start the process. If there is an update available, the E1X DAC will then begin downloading. The display will show the progress of the downloads. Once the updates are complete, the E1X DAC will reset itself and begin its startup sequence. The new firmware rev will then be displayed.



# Connecting to Your Network

UPnP Universal plug and play is a set of protocols designed to allow consumer devices to interact over a network. The network streaming system is made up of three standard UPnP components. UPnP control point, Media Renderer and Media server. All media, song, and track information is stored and accessed through your streaming service or server. This can be a NAS (Network attached storage) or computer. The Control point is your tablet or smart phone, this device connects the particular media from the server and passing it to the renderer (E1X DAC) to play. The renderer directly retrieves media from the server decodes and plays the selection as it arrives over the network. It works in the same way streaming music from a subscription service.

Setting up the network properly requires a standard infrastructure that includes the following components; Router, Network player (E1X DAC), Wireless access point (WAP), Wireless control point. The Bel Canto SEEK app is a control point application that will allow users to view / select available renderers view / select available media servers and browse / select / playback music through the E1X DAC. The Bel Canto SEEK app is currently available for iOS.

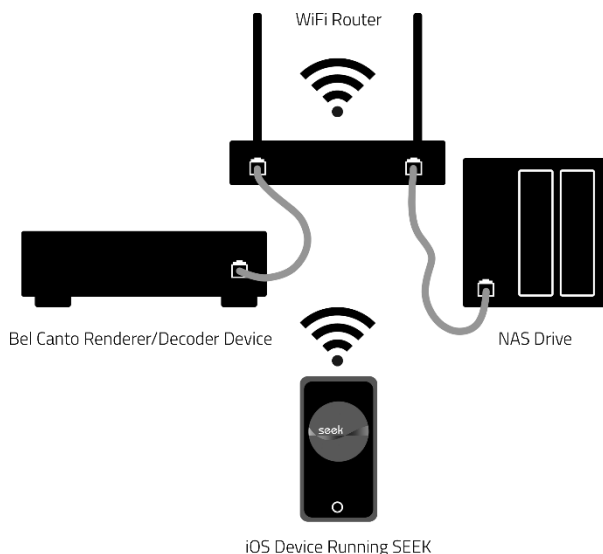

The E1X DAC Network Bridge is Roon Ready. If you have a Roon account, you need to install Roon Server on your NAS drive or on a networked PC/Mac. You can then use Roon Remote to control playback. More information on Roon and its hardware requirements can be found at <https://roonlabs.com>.



## Loading Bel Canto SEEK onto Your iOS Device

From your iOS device open apps and search Bel Canto SEEK. Download free app.

SEEK controls content from TIDAL, Qobuz, cloud storage, and VTuner, allowing you to choose music selections from a variety of sources. Correctly setting up your subscription account is important and will directly impact the quality of the audio experience. Please be sure to select HI/FI setting in your subscription account to ensure the highest quality data is delivered to your system.

Your subscription account (Tidal or Qobuz) is independent of SEEK. Your subscription service agreement must be current for SEEK to access music content from your subscription account.

Subscription account setup

TIDAL: [WWW.TIDAL.COM](http://WWW.TIDAL.COM)

Qobuz: [WWW.QOBUZ.COM](http://WWW.QOBUZ.COM)

**Set Up Subscription:** OPEN TIDAL or Qobuz account, go to "Settings" and "Quality" set the streaming resolution select 'HiFi' in your "WiFi" setting for the highest broadcast audio quality.

### IMPORTANT:



Once you set up your subscription account in TIDAL or Qobuz, you will need to use the same username and password in the SEEK App to connect to your subscription account. **You will also have to make selections in the SEEK app to ensure the highest resolution audio is broadcast to the E1X DAC.**

**Setting Up SEEK:** Open SEEK and open the "Browser" at the bottom of your screen select Tidal and press the 3 horizontal lines in the upper left corner to access the drop-down menu. (This opens several options you will want to become familiar with to utilize all the functions in SEEK). Select "Settings" at the bottom of the menu. Here you can select for Tidal 'Hi/Fi/Master' or Qobuz 24/192 streaming output. This controls your Streaming service from TIDAL and Qobuz through SEEK and allows SEEK to pass the Hi Resolution files you've selected in your subscription account to your component. Press the return arrow to go back one screen.

## Making the connection from SEEK to the E1X DAC:

1. Main screen press cog wheel (Image1)
2. Select device set up (Image2)
3. Choose the device, each E1X DAC has a unique serial number (Image3)
4. Selecting the device displays Firmware and serial number. This is where you check for firmware updates. (Image4)
5. Pressing the arrow back goes back one page until you reach the main page.

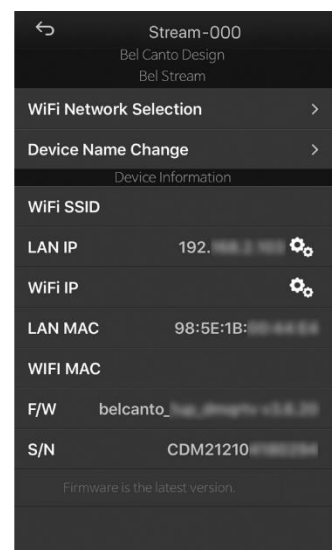
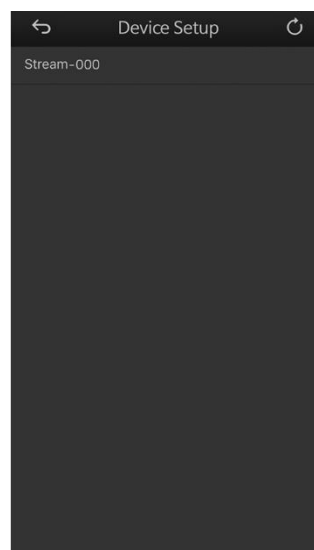
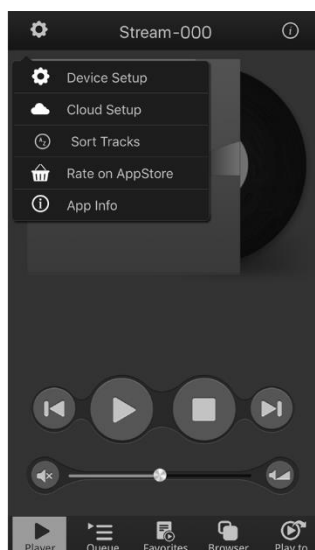
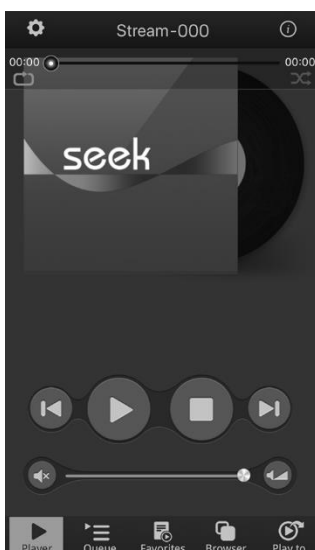

## Selecting music:

1. Press browser (Image1)
2. Choose Internet music source from library: Tidal, Qobuz, Vtuner, Cloud, Local Server (USB-A drive) (Image1)
3. Choose from Playlists, Albums, Tracks (explore using the search function to find music) (Image2)
4. Press "more" to open categories of music and Masters (MQA) on Tidal (Image2)
5. Press any of the headings in Qobuz to search music that will play up to the selected rate in settings (Image3)

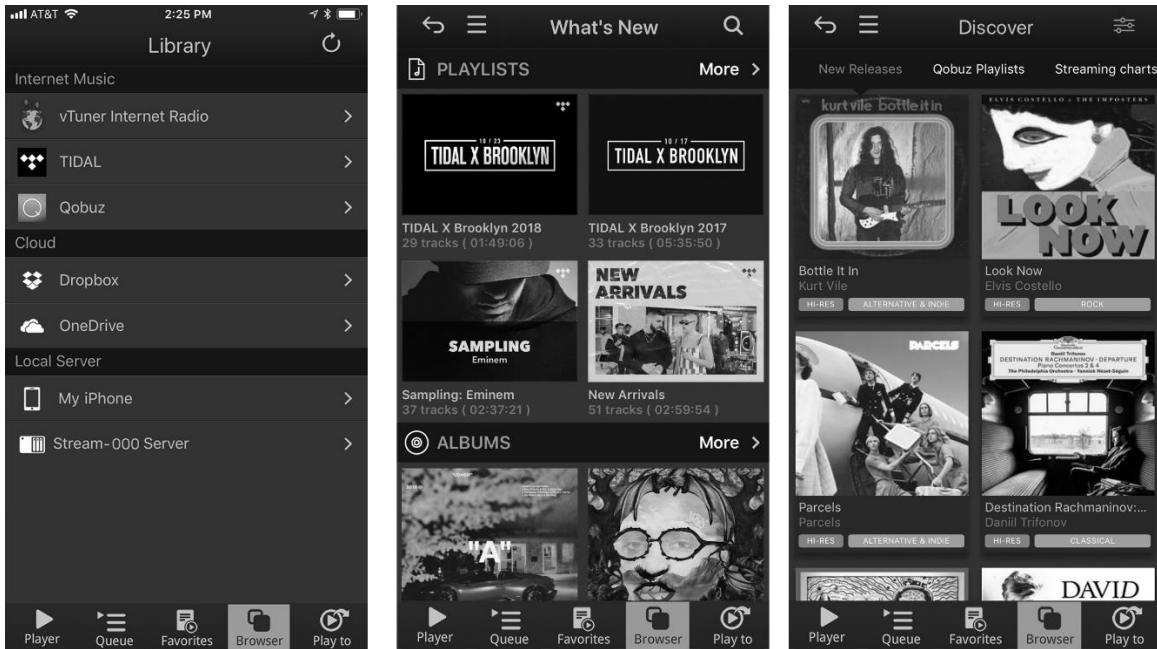

## Browser music management:

1. Press the 3 horizontal lines while in the browser screen in the upper left corner to open drop-down menu, each category contains pre-selected music as described in addition to 'My Favorites' and 'My Playlist' that allow you to place selected music in each folder. (Image1)
2. The 3 circles on the right of each track, (Image3) will open a drop-down menu (Image2) that offers options; "go to album" or places the track in a folder "Favorites" (Image4) or "add to Queue" or "search artist".
3. Select a specific track from the browser by pressing the line item, this will play once or repeat depending on your settings indicated by the blue loop symbol on the upper left portion on the main page.
4. *Middle bar (Image3)* play symbol plays the complete album, star places the album in a favorite folder and 3 dots opens drop down menu allowing you to add to a playlist or Queue.

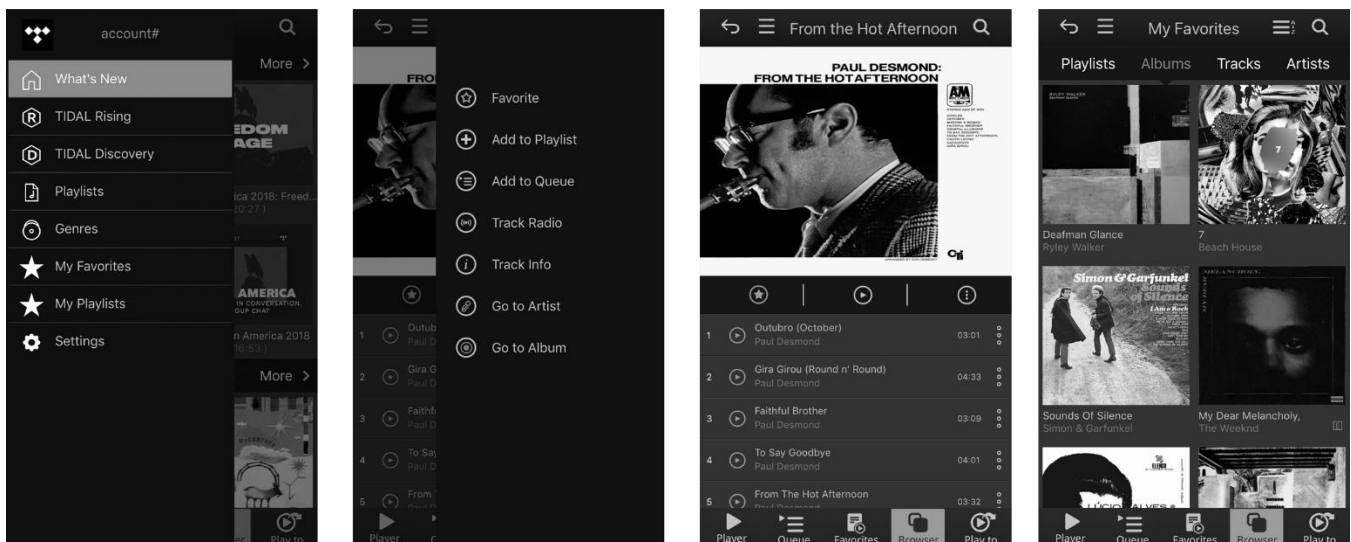

## Using the SEEK app

1. Press the "Play to" at the bottom of the main screen, (Image1) this displays devices on your network. And lets you select the device you would like to send music.
2. Main screen (Image2) shows album art and controls track, pause, stop function and volume management
3. Touching the album artwork toggles the display that shows the codec, bit/ sample rate and time remaining in track (Image3)
4. Managing volume, we suggest you use the micro volume (Image3) when changing levels, press the speaker up symbol at the right of the volume slider (Image2) to choose micro volume.
5. Blue circle upper left corner (Image2) gives you the option to repeat track, play track once, advance track.
6. 3 dots upper right corner opens a page to select gapless track play
7. You should always see the device you are playing to at the top of the screen (image1) when in network.

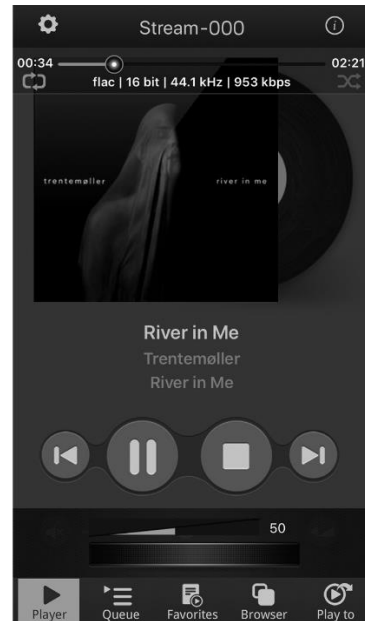
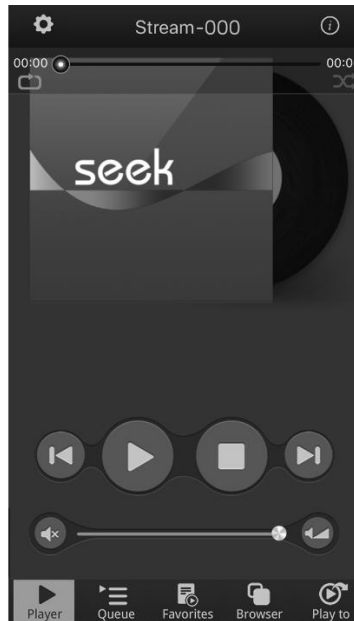
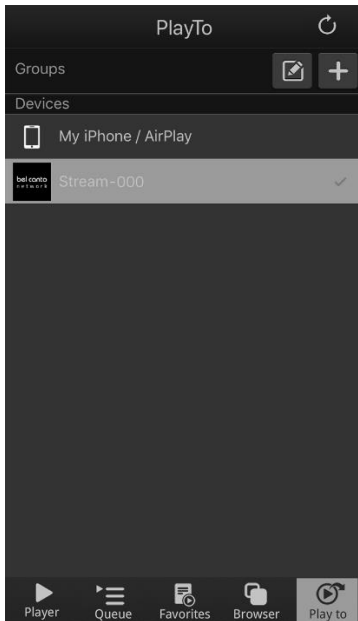

# Specifications

## Maximum Data Input Rates:

24bit Data to 192ks/s:	AES, SPDIF, TOSLINK
24bit Data to 192ks/s, MQA, and DSD 64:	10/100 Ethernet
24bits at 384KS/s, MQA, and DSD64/128 (DoP):	USB2 Audio

## Low Level Outputs:

Line Level Analog:	4.5Vrms with Bass Management
Headphone:	4.5Vrms maximum, 32ohm minimum load

## MM/MC Input:

Input Sensitivity:	MM: 2.5mV to 5mV; MC: 0.25mV to 0.5mV
Input Load:	MM: 47K ohms; MC: 50, 100, 500, 1000
RIAA Accuracy:	+/- 0.25dB, 50Hz – 15kHz
THD+N:	<0.01% 1kHz A-weighted
SNR:	>70dB A-weighted

## Line Inputs:

Maximum Input:	2.2 Vrms RCA
Input Impedance:	10K ohms RCA
THD+N:	0.003%, 1kHz
Dynamic Range:	110dB, A-weighted 20Hz-20kHz

## Main Outputs:

Balanced XLR Output and Impedance:	5.5Vrms, 100 ohms
Minimum Load:	600 ohms
RCA Output and Impedance:	2.75Vrms, 100 ohms

## Performance:

Dynamic Range:	126dB A-weighted
THD+N:	<0.001% 1W, 1kHz, 4 ohms
IMD (CCIF):	<0.001% 1W, 18.5:19.5kHz 1:1, 4 ohms

## General:

Power Usage On:	20W
Power Usage Off:	0W
Power Requirement:	100-120VAC or 230-240VAC 50/60Hz Internally Set
Size:	17.75 W x 14.75 D x 3.3 H inches – 451 x 375 x 84mm
Weight:	16lbs (7.3 kg)



## Declaration of Conformity

---

We, the offerer,  
Bel Canto Design, Ltd., Minneapolis, Minnesota 55401 USA  
acknowledge our sole responsibility, that the product:

**Kind of equipment:** Bel Canto E1X Series  
**Type designation:** E1X DAC Control/Preamp

in accordance with EMC Directive 2004/108/EC,  
is in compliance with the following norm(s) or documents(s):

**Technical regulations:** EN 55013:2001 + A1:2003 + A2:2006  
  
EN 55020:2007 + A11:2011  
  
EN 61000-3-2:2006 + A2:2009  
  
EN 61000-3-3:2008

in accordance with Low Voltage Directive 2006/95/EC,  
is in compliance with the following norm(s) or documents(s):

**Technical regulations:** EN 60065  
  
IEC 60065

in accordance with Ecodesign Requirements for Energy Related Products Directive 2009/125/EC,  
is in compliance with the following norm(s) or documents(s):

**Technical regulations:** EC No. 1275/2008, EN 62301

is in conformity with Directive 2011/65/EU of the European Parliament and of the Council of 8 June 2011 on the restriction of the use of certain hazardous substances in electrical and electronic equipment, and it has been demonstrated that the requirements specified in Article 4 of such Directive have been met.

June 19, 2019

---

Bel Canto Design  
221 1<sup>st</sup> Street North, Suite 300, Minneapolis, MN USA

John Stronczer  
CEO



# bel canto

221 1<sup>st</sup> Street North, Suite 300

Minneapolis, MN 55401

P: 612.317.4550 F: 612.359.9358

[info@belcantodesign.com](mailto:info@belcantodesign.com)

<http://www.belcantodesign.com>

©2019 Bel Canto Design, LTD